

OXYGEN CONCENTRATOR PATIENT INSTRUCTION BOOKLET

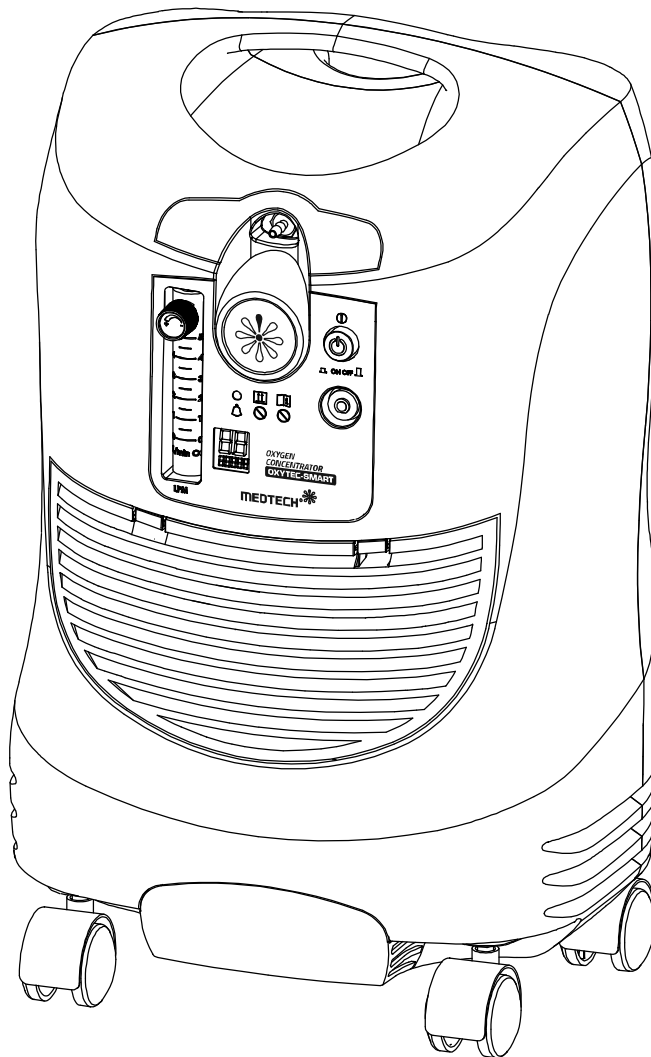

OXYTEC-SMART

INTRODUCTION

Your doctor has prescribed a supplemental Oxygen therapy to treat your respiratory condition.

Your Oxygen Concentrator works to supply a constant source of high concentration supplemental Oxygen

Be sure that you read and understand the information in this instruction guide. By following these simple instructions and the advice of your physician, your Oxygen Concentrator will become an effective addition to your therapeutic routine.

Carefully read these instructions and keep them in a safe place for future reference.

Use the unit only as described in this Patient Instruction Booklet

The Oxygen Concentrator is a medical device and is to be used only upon medical prescription.

The contents of this Patient Instruction Booklet are in no way to be understood as medical advice and under no circumstances replace medical / clinical judgment, advice & experience.

Precautions

The operating, maintenance and cleaning procedures, warnings and cautions as instructed in this INSTRUCTION BOOKLET must be followed Please read the information in the instruction manual and any other literature included with the product before using the device. It is important to follow all instructions in this manual including Safety instructions. Failure to follow the instructions may result in potentially hazardous situation resulting in serious injury.

Specifications given in the instruction booklet are subject to change without notice
Data given here is correct to the best of our knowledge at the time of going to print .
No responsibility accepted for any misprint, admission or omission.

CONTENTS

INTRODUCTION	
Important Safety Rules	Page 2
Section 1 Introduction	Page 6
Section 2 Concentrator Components	
2.1 Front of Concentrator	Page 7
2.2 Back of Concentrator	Page 8
2.3 Humidifier Bottle and accessories	Page 9
Section 3 How to Operate Your Oxygen Concentrator	
3.1 Humidifier Bottle Connection	Page 10
3.2 Cannula Connection	Page 11
3.3 Starting the Concentrator	Page 12
3.4 How to read Flow Meter	Page 13
3.5 Turning the Concentrator Off	Page 14
3.6 Alarms and indications	Page 14
3.7 Service Intervals	Page 15
3.8 Checking of flow and leakage	Page 16
Section 4 Care and Cleaning	
4.1 Humidifier Bottle	Page 16
4.2 Outside Cabinet	Page 17
4.3 Cabinet Filters, Compressor Inlet Primary Filter	Page 17
4.4 Compressor Inlet Secondary Filter	Page 18
4.5 Nasal Cannula	Page 18
Section 5 Troubleshooting	Page 19
Section 6 Product Specifications	Page 22
Section 7 Spare Parts /Accessories	Page 25
Section 8 Disposal	Page 26
Section 9 Symbols / Warnings	Page 26
Section 10 Limited Warrantee	Page 27

Important Safety Rules



- In the event of an alarm or if you are experiencing any signs of discomfort, consult your Equipment Provider and /or your physician immediately
- Open flames during oxygen therapy are dangerous and is likely to result in fire or death. Do not allow open flames within 2 m of the oxygen concentrator or any oxygen carrying accessories
- Do not use oil, grease, or petroleum-based products on or near the unit.
- Use only water-based lotions or salves that are oxygen-compatible before and during oxygen therapy. Never use petroleum or oil-based lotions or salves to avoid the risk of fire and burns
- Do not lubricate fittings, connections, tubing, or other accessories of the oxygen concentrator to avoid the risk of fire and burns
- Do not use in an explosive atmosphere.
- Disconnect the power cord from the electrical outlet before cleaning or servicing the unit.
- Electrical shock hazard. Do not open the unit while plugged in or in operation.
- Only your Equipment Provider or a qualified service technician should open the unit or service the unit.
- Smoking during oxygen therapy is dangerous and is likely to result in facial burns or death. Do not allow smoking within the same room where the oxygen concentrator or any oxygen carrying accessories are located. If you intend to smoke, you must always turn the oxygen concentrator off, remove the cannula and leave the room where either the cannula or mask or the oxygen concentrator is located. If unable to leave the room, you must wait 10 minutes after you have turned the oxygen concentrator off before smoking
- Do not leave a nasal cannula under bed coverings or chair cushions. If the unit is turned on but not in use, the oxygen will make the material flammable. Set the ON-OFF power switch to the OFF position when the unit is not in use.
- Do not use extension cords with this unit or connect too many plugs into the same electrical outlet
- Sparks in electrical outlets may cause fire hazard
- Do not use your oxygen concentrator in the presence of flammable gases
- Place the device in a ventilated area free from smoke and atmospheric pollution; (be sure the cabinet air filter is not obstructed).
- To ensure receiving the therapeutic amount of oxygen delivery according to your medical condition, your MEDTECH LIFE OXYTEC-SMART oxygen concentrator must:
 - be used only after one or more settings have been individually determined or prescribed for you at your specific activity levels.

- be used with the specific combination of parts and accessories that are in line with the specification of the concentrator manufacturer and that were used while your settings were determined.
- Do not use in a specifically magnetic environment such as (MRI, X-ray, etc.)
- Use the power cord provided, and check that the electrical characteristics of the power socket used match those indicated on the manufacturer's plate on the back panel of the machine.
- The oxygen delivery setting has to be determined for each patient individually by their physician, with the configuration of the equipment to be used, including accessories.
- The proper placement and positioning of the cannula is critical to the effectiveness of the therapy.
- It is recommended to have an alternate source of supplemental oxygen on standby in the event of a power outage, alarm condition, or mechanical failure in the machine. Consult your physician or Equipment Provider for the type of reserve system required.
- U.S. Federal law restricts this device to sale by or on order of a physician only.
- Clean and disinfect the oxygen kit, humidifier bottle before using them for the first time after purchase.
- If the accessories has not been used for a long period of time, clean and disinfect the oxygen kit and humidifier bottle before use.
- Be sure to wash the parts after use, and ensure that they are thoroughly disinfected and dried, and stored in a clean location in a sealed bag.
- Do not use or store the device where it may be exposed to high humidity, noxious fumes, volatile substances, flammable gases, heat source, corrosive fluids and gases.
- Use only spare parts recommended by the manufacturer to ensure proper function and to avoid the risk of fire and burns. The responsible organization is accountable for ensuring the compatibility of the oxygen concentrator and all of the parts or accessories used to connect to the patient before use
- Never plug, unplug or handle the device with wet hands.
- The device is not waterproof. Do not spill water or other liquids on the device. In the event of spillage, immediately unplug the power cord and wipe-off the liquid with gauze or other absorbent material & ensure it is returned to an authorized service dealer.
- Do not operate the device with a damaged power cord or plug.
- Keep the power cord away from heated surfaces.
- Do not use while bathing.
- Do not place the product on an inclined surface.
- Always lock the castor wheel before you start using the machine.
- The product should never be left unattended when plugged-in.
- Do not use this product with DC to AC converter, or with any AC voltage

and/or frequency other than specified.

- The power cord and oxygen tube should be kept away from children, invalids it may cause strangulation hazard.
- Provide close supervision when this device is used by, or near children or invalids, or persons who cannot express their consent.
- Do not use the device while sleeping or drowsy.
- Make sure that the parts are attached correctly.
- Do not tilt or shake the device while in use.
- Do not use or store the device while the tube is creased or kinked.
- Use only original oxygen tube, nasal cannula, humidifier bottle, and air filter.
- Do not subject the device or parts to any strong shocks such as dropping the device on floor.
- Do not disassemble or attempt to repair the device, since no parts inside are user serviceable.
- Do not use microwave oven, dish dryer or hair dryer to dry the device or parts.
- Approved for human use only.
- Do not use Ethylene Oxide gas disinfection or low temperature plasma sterilizer to disinfect the device.
- Always unplug the device from the power outlet after use and before cleaning.
- Plug the device into the appropriate voltage outlet. Do not overload power outlets or use extension cord.
- Do not misuse the power cord.
- Do not wind the power cord around the device.
- Do not pull the power cord strongly, or do not pull the device by the power cord. Use castor wheels to move the device.
- When using this device, there will be some noise and vibration by the compressor. This is normal and does not indicate malfunction.
- Operate the device only as intended. Do not use the device for any other purpose.
- Make sure that the oxygen tube is securely attached to the device and does not come loose.
- To completely isolate the device from the power source, unplug the plug from the power outlet.
- No part of this device is to be serviced or maintained while in use with the patient.
- It is recommended to check the accuracy of flowrate and oxygen concentration of your device every 6 months. Contact your service provider to check it.
- Do not use this device below or above the operating conditions specified in section 6.0 of this manual. The use of this device outside the specified

operating conditions is expected to adversely affect the flowrate and the percentage of oxygen and consequently the quality of the therapy

- Geriatric, pediatric or any other patient unable to communicate discomfort can require additional monitoring to convey the information about the discomfort and or the medical urgency to the responsible care giver to avoid harm.

INTENDED USE

This product separates Oxygen from atmospheric air and delivers highly concentrated Oxygen to the patient. The flow and duration of therapy would be as prescribed by their physician.

Intended user

Certified medical experts such as, doctors, nurses, therapists etc. Caretaker or patient under guidance of qualified medical experts. Users capable of reading and understanding the contents of this INSTRUCTION BOOKLET and general understanding of the product

Intended patients

Can be used on pediatric or adults. However should not be used on patients who are not breathing on their own or those who are unconscious or those who cannot express their feelings to the caregiver.

Environment

The product can be used for indoor use only in a doctor's office, or healthcare facility .Please see detail environmental conditions for use, transport and storage in Product Specifications.

Durable Period (Expected Service Life)

The durable period is based on use of oxygen concentrator 3 hours a day, and provided the product is used in accordance with this INSTRUCTION BOOKLET

Oxygen Concentrator Machine	3 years
Compressor Inlet Secondary Filter	3 months
Cabinet Filters	1,000 hours
Accessories	1 Year



Note: Filter replacement depends upon environmental conditions and may need to be replaced earlier also if found to be dirty or clogged.

1.0 Introduction

This Patient Instruction Booklet will acquaint you with your Oxygen Concentrator. Make sure you read and understand all of the information contained in this guide before operating your concentrator. Should you have any questions, your Equipment Provider will be happy to answer them for you.

Why Your Physician Prescribed Oxygen

Many people today suffer from a variety of heart, lung, and other respiratory diseases. A significant number of these patients can benefit from supplemental oxygen therapy for respiratory care.

Oxygen is a gas that makes up about 21% of the room air we breathe. Our bodies depend on a steady supply of oxygen to function properly. Your physician has prescribed supplemental oxygen therapy because your body is not able to get enough oxygen from room air. Your physician prescribed a flow sufficient to improve your condition. It is advised to follow the flow and therapy duration as prescribed by your doctor, unauthorized change in the flow and therapy times may be dangerous. Please keep in mind that unauthorized oxygen therapy can be dangerous. You must seek medical advice before you use this unit.

What is an Oxygen Concentrator?

Oxygen concentrators were introduced in the mid-1970s and have become the most convenient, reliable source of supplemental oxygen available today. Without an oxygen concentrator, the average patient would require a delivery of 12 bottles/cylinders of oxygen each month. Your oxygen concentrator produces all the oxygen you need, with no deliveries required. The air we breathe contains approximately 21% oxygen, 78% nitrogen, and 1% other gases. In the concentrator, room air passes through a regenerative adsorbent material called molecular sieve. This material separates the oxygen from the nitrogen and other gases. The result is a constant supply of high concentration supplemental oxygen that is delivered to the patient.



Note: There is never a danger of depleting the oxygen in a room when you use your Oxygen Concentrator.

2.0 Concentrator Components

2.1 Front of Concentrator

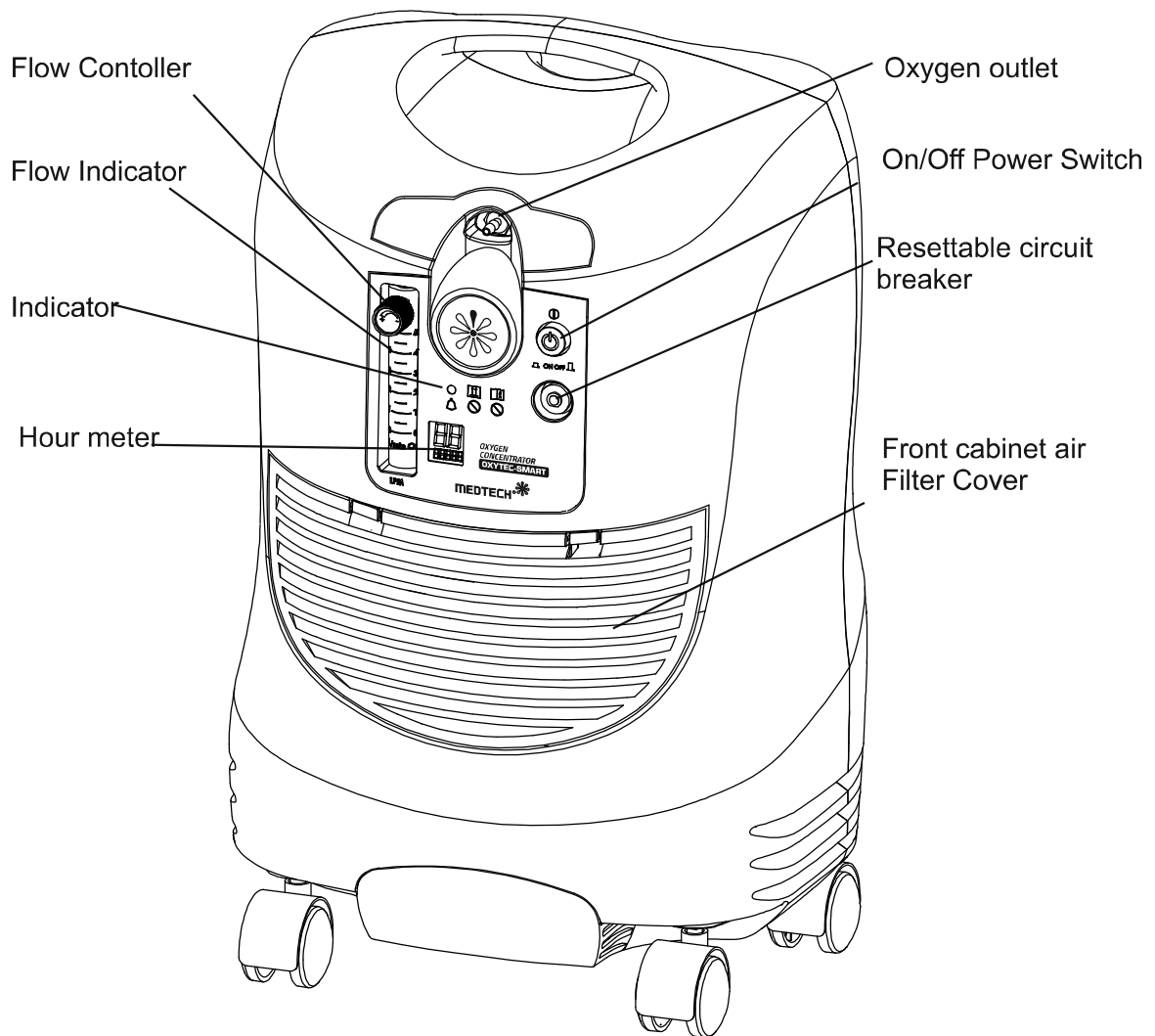

Fig 2.1

2.2 Back of Concentrator

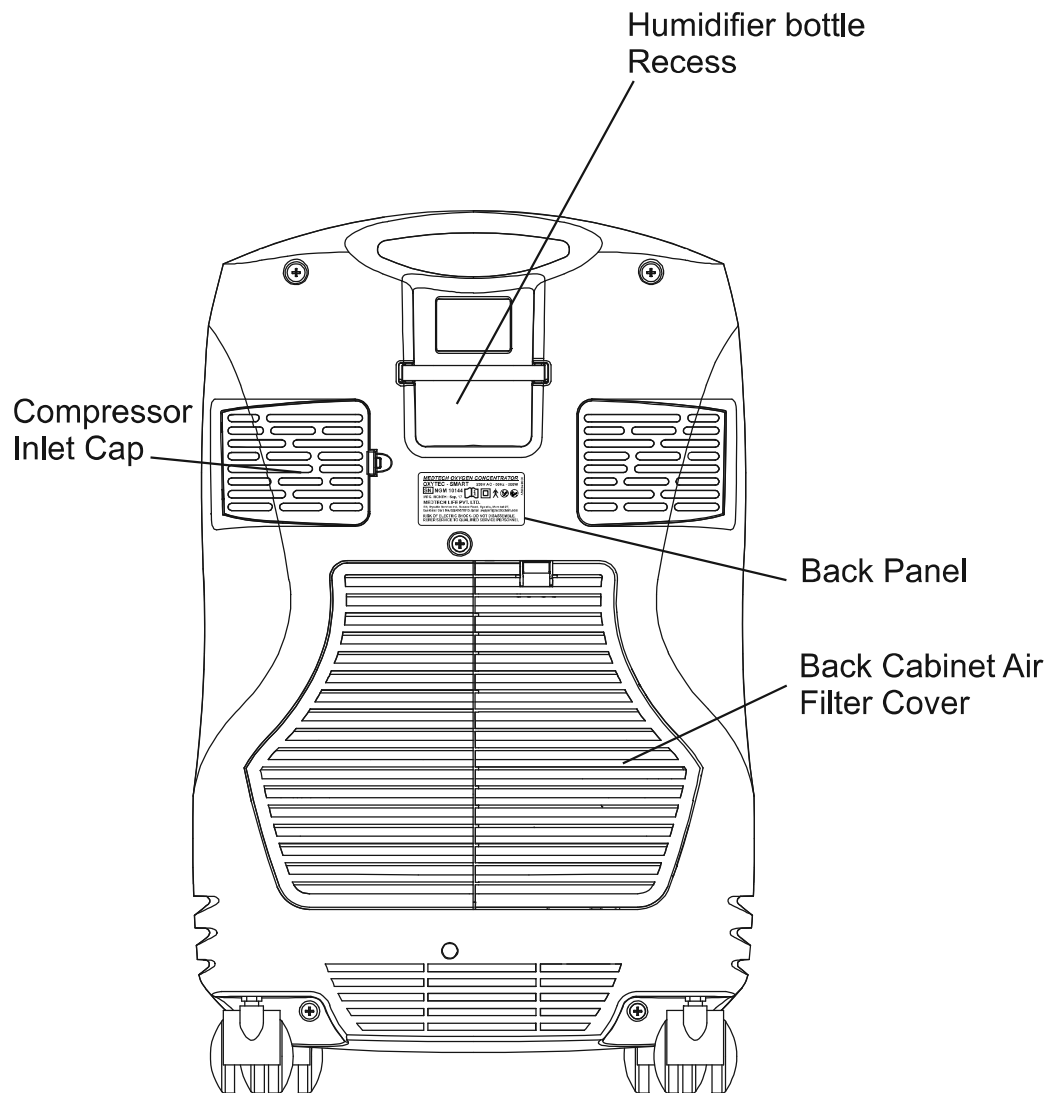

Fig 2.2

2.3 Accessories

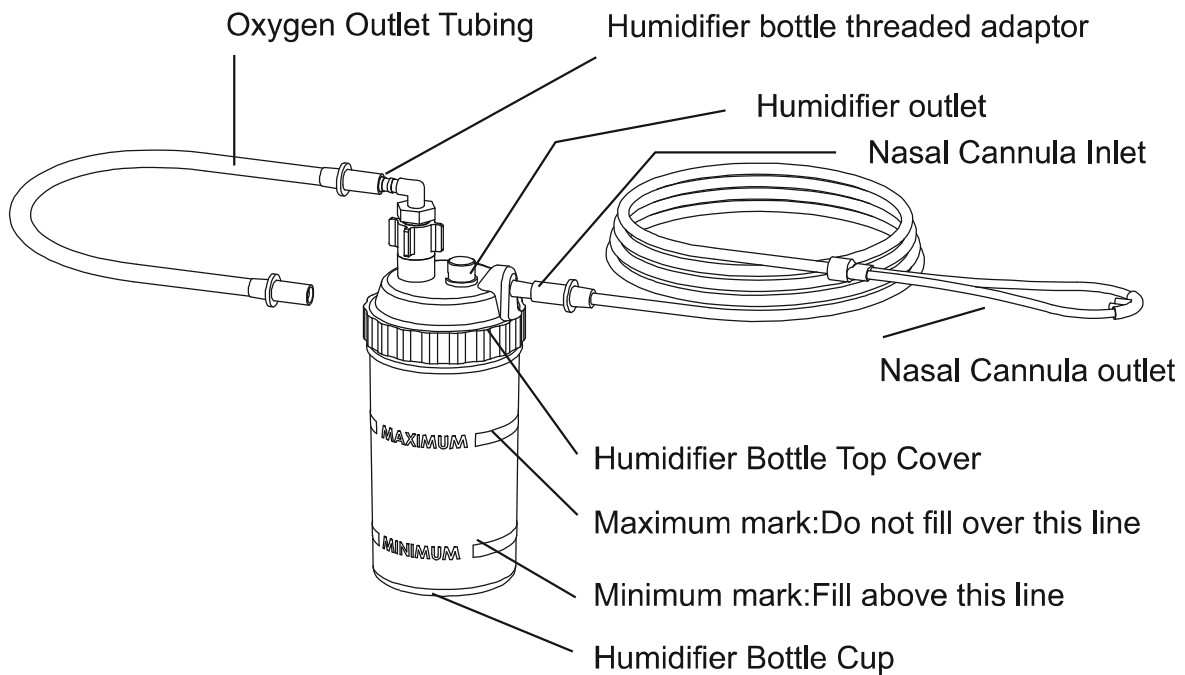

Fig 2.3

The following accessories are included with your oxygen concentrator:

- Humidifier Bottle - includes Humidifier bottle top cover, Humidifier bottle cup.
- Nasal Cannula.
- Humidifier Bottle Threaded adapter.
- Oxygen Outlet Tubing.
- Patient Instruction Booklet.

For separate pictures of individual accessories refer to Section 7 Spare Parts/ Accessories.

Please read label on box for exact contents and accessories provided the specifications and accessories provided may vary with different models.

3.0 How To Operate your Oxygen Concentrator

3.1 Humidifier Bottle Connection

If additional humidification is required with your oxygen therapy, perform the following steps each time you fill or clean the humidifier, which may have been initially set up for your use.

1. Remove the humidifier bottle from the humidifier bottle recess.
2. Open the humidifier bottle. If you have a pre-filled bottle, do not perform this step. Proceed to step 5.



Fig 3.1



Fig 3.2

3. Fill the humidifier bottle cup with cool or cold water (distilled water is preferred) to the fill line indicated on the bottle. **DO NOT OVERFILL.**
4. Re-connect the top cover to the humidifier bottle.
5. Connect the humidifier bottle threaded adapter

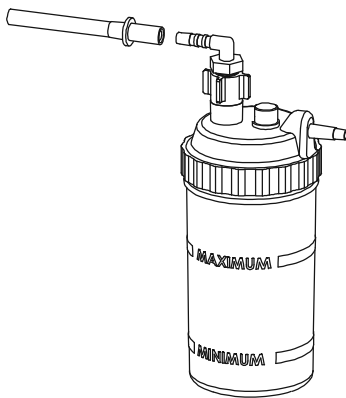

Fig 3.3

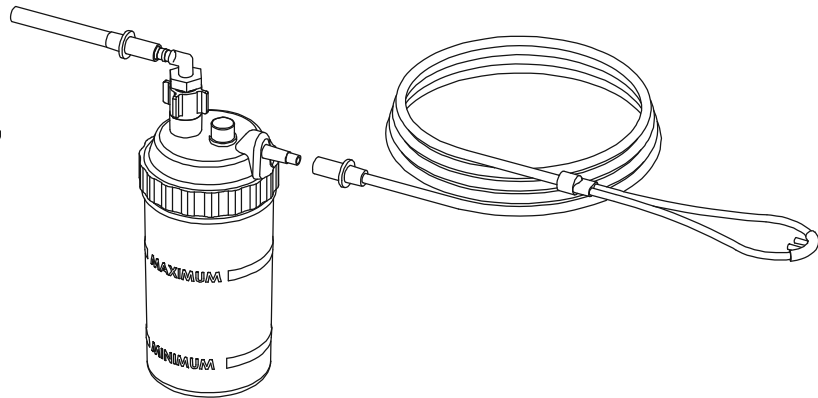

Fig 3.4

6. Connect the Oxygen Outlet tubing to the humidifier bottle threaded adapter and the other end of the oxygen outlet tubing to the oxygen outlet in the machine.

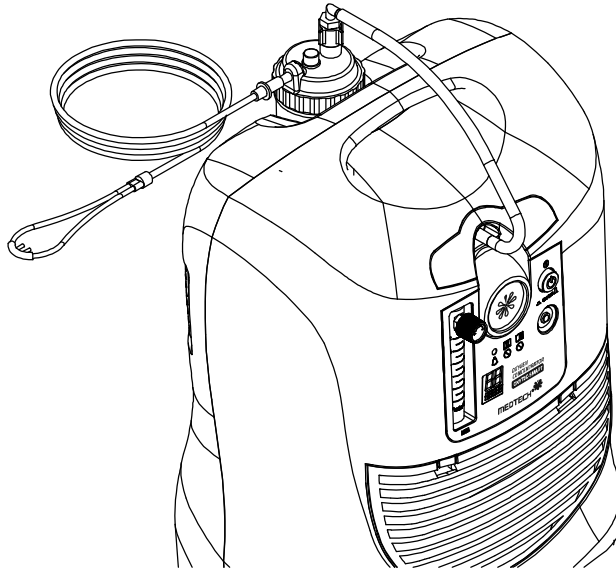



Fig 3.5

7. Place the humidifier bottle in the humidifier bottle recess on the back of the concentrator.
8. Connect the nasal cannula inlet to the outlet of the humidifier outlet

 If the humidifier bottle tubing is not properly connected to the humidifier bottle fitting or to the oxygen outlet, an oxygen leak can occur which can be a fire hazard.

3.2 Nasal Cannula Connection

Connect the nasal cannula inlet to the unit's oxygen outlet, or to the optional humidifier's oxygen outlet.

The oxygen comes out through the nasal port and the nasal port of the nasal cannula is to be secured near the nostrils to breath the oxygen. Adjust the nasal cannula to suit your face

3.3 Starting the Concentrator

- ⚠ Do not use extension cords with this unit.
- ⚠ Position the unit away from curtains or drapes, hot air registers or heaters. Be certain to place the unit on a flat surface and make sure all sides are at least 1 foot (30 cm) away from a wall or other obstruction. Do not place the unit in a confined area. Choose a dust and smoke free-location away from direct sunlight.
- ⚠ It is very important to follow the prescribed level of oxygen flow. Do not increase or decrease the flow until you first consult your physician.
- ⚠ Ensure concentrator is operated in an upright position.
- ⚠ Do not smoke near this unit - Risk of fire hazard.
- ⚠ Do not operate the unit anywhere near open flames, sparks - Risk of fire hazard.

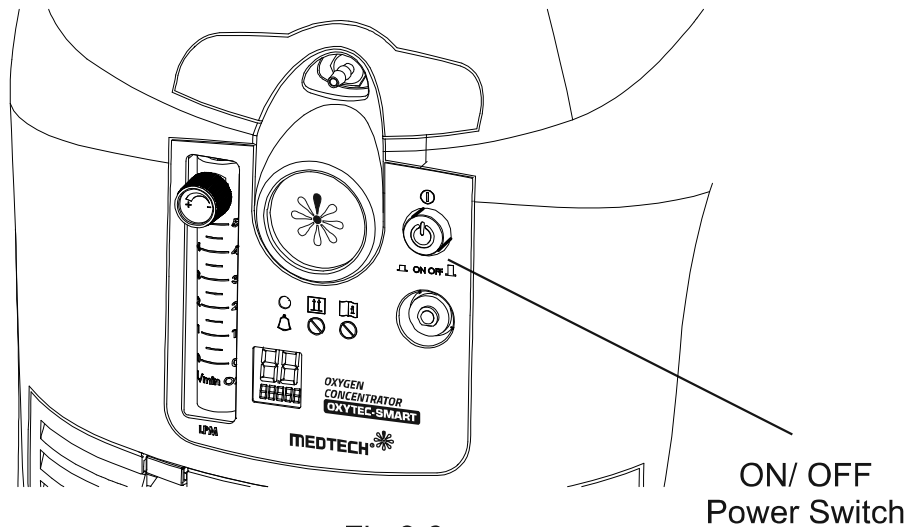

Fig 3.6

1. Locate the unit near the electrical outlet in the room where you spend most of your time.
2. Insert the power cord plug into the electrical outlet.
3. Press the ON/OFF power switch to turn the unit on. An audible alarm will loudly sound & indicator will turn on for approximately 3 seconds indicating the machine is turning on
4. The low oxygen concentration indicator remains Orange for a fewminutes until the oxygen concentration reaches minimum concentration requirements, Once oxygen concentration reaches required levels the indicator will turn green. (only pertains to unit

equipped with an Oxygen Monitoring sensor. Please check the product specification for details). In machines without the low oxygen concentration indicator the indicator will turn green immediately.

5. To set the flow of oxygen, turn the flow controller left/anticlockwise (to increase flow) or right/clockwise (to decrease flow) until the ball inside the flow indicator centers on the flow line number prescribed by your physician. To view the flow indicator at the proper angle, note that the back line and the front number line must give appearance of one line.
6. Ensure that all of the parts are connected correctly so as to avoid leaks.
7. The concentrator is now ready for use.
8. The required oxygen concentration is normally obtained within ten minutes after the unit is started.



NOTE

If oxygen does not seem to flow, first verify that the flow indicator ball is registering a flow. Then, place the tip of the cannula into a glass of water; if bubbles come out of the cannula, oxygen is flowing. If bubbles do not appear, refer to troubleshooting

3.4 How to read Flow Meter

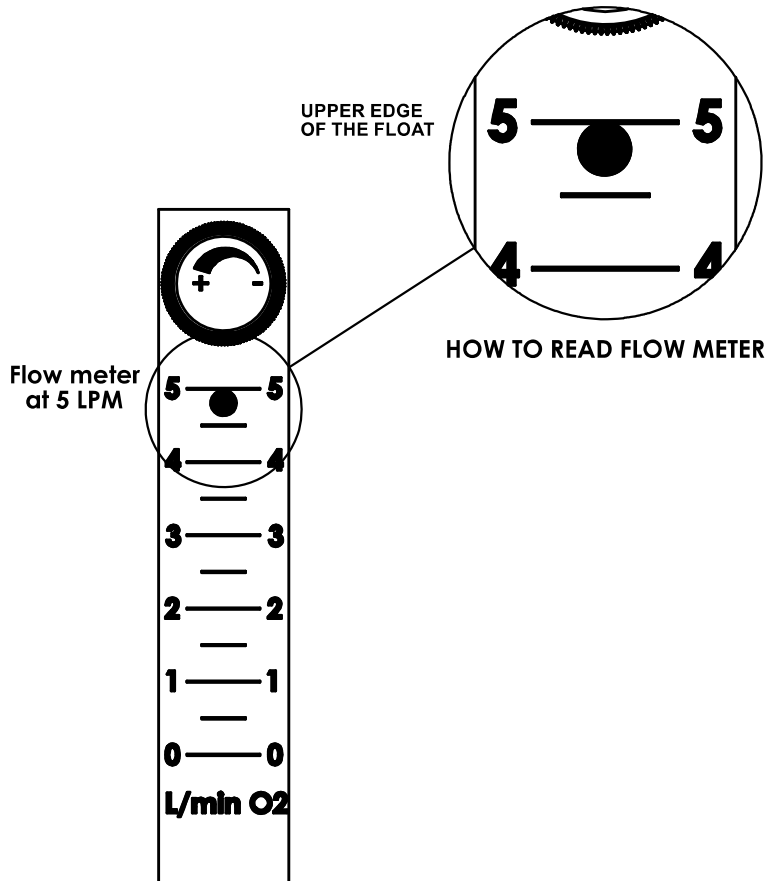

3.5 Turning the Concentrator off

- 1 Press the On/Off power switch to turn the unit off . (in ON condition the power switch rests flush with the concentrator front body and in OFF position the power switch will rest about 5 mm outside the concentrator front body).
- 2 There is some oxygen stored in the unit and the flow indicator will show some flow after turning off the unit, till the stored oxygen is depleted.



NOTE

In OFF condition the power switch rests about 5 mm outside the concentrator front body. See Fig 3.7

In ON position the power switch will rest flush with the concentrator front body. See Fig 3.8

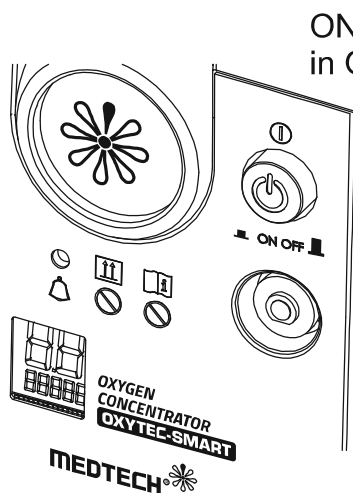

Fig 3.7

ON-OFF Switch
in OFF Position

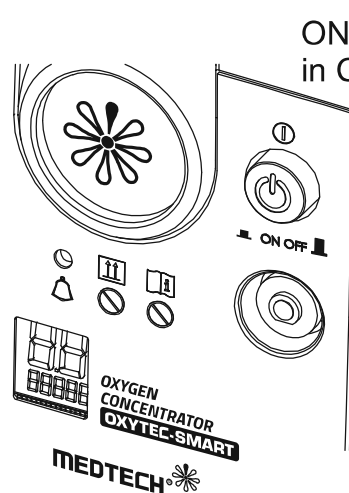

Fig 3.8

ON-OFF Switch
in ON Position

3.6 Alarms and indications

No voltage detection:

In the event of a loss of mains power and the machine being switched ON or loss of mains power when the machine is already ON, the indicator and audible alarm will blink ON and OFF in intermittent fashion

This alarm will function on till internal batteries are fully discharged, normally 3 minutes after which the alarm will be disabled.



NOTE

For this alarm to be functional, the internal capacitive battery of the machine must be charged. It takes approximately 10 minutes of operating the concentrator to charge the internal batteries. The batteries get drained normally after a few days of the machine not being used.

The No voltage detection will not be functional when battery is not charged.

User Action	Indicator	Display	Buzzer	Explanation	Action to take
Machine Off	OFF		OFF	Machine Is In Off Condition	none
Machine started	GREEN	07	ON for 3 Seconds then OFF	Machine Switched On Normal Operation	Normal operation No action required
After 45 sec of machine start	GREEN	07 00-00			
	RED Flashing	E1	Beep On Off Cyclic	Mains Power Lost While Machine is working	See Section 5
	RED Flashing	E2	Beep On Off Cyclic	High Temperature Alarm in Machine	See Section 5
	RED Flashing	E3	Beep On Off Cyclic	High Temperature Alarm in Compressor	See Section 5
	RED Flashing	E4	Beep On Off Cyclic	Low Pressure Alarm in Machine	See Section 5
	RED Flashing	E5	Beep On Off Cyclic	High Pressure Alarm in Machine	See Section 5
	RED Flashing	E6	Beep On Off Cyclic	Valve Error in Machine	See Section 5

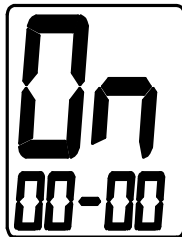
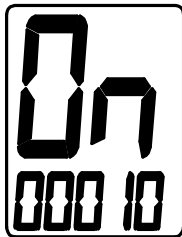

NOTE

When starting of the machine the hourmeter will show total hours the machine has run. After 45 seconds the hourmeter will change to the number of hours machine has been running for current session.

3.7 Service Intervals

Please read the reading on the hour-meter and take the following action:

For hour-meter reading 3000, 6000, 9000, 12000 – check and clean the Front Cabinet Air Filter, Back Cabinet Air Filter, Compressor Primary Filter.

As a good practice it is advisable to check the filters every week or 15 days and clean if they appear clogged this will ensure peak performance and long machine life.

Check and replace the Compressor Secondary Filter, if necessary.
The Compressor Secondary Filter cannot be cleaned. It needs to be replaced.

See Section 4.4 on instructions how to replace the filters.

For hour-meter reading 15000 and above the machine should be sent to authorized service station for complete checkup and replacement of end of service parts.

3.8 Checking of flow and leakage

To check the flow of gas turn the machine ON, and turn the flow meter knob in either direction. The pointer ball in the flow meter should go up and down as you rotate the knob in back-n-forth direction. To check the leakage in the accessory, dip the prongs of the cannula in a bucket of water. If the bubbles come out, then there is no leakage in the tubing.

4. Care and Cleaning

 Disconnect the power cord from the electrical outlet before you clean the cabinet or control panel.

 Do not use liquid directly on the unit. Do not use any petroleum-base solvents or cleaning agents.

 Clean the cabinet, control panel, and power cord only with a mild household cleaner applied with a damp cloth or sponge, and then wipe all surfaces dry.

4.1 Humidifier Bottle

- Empty the water from the humidifier bottle.
- Rinse the humidifier bottle under running water.
- To clean and disinfect the humidifier, follow your Equipment Provider's instructions, or the instructions included with the humidifier bottle. Disinfect the humidifier parts by immersing them in a disinfectant solution (in general, we recommend using a solution of 1 part vinegar diluted with 10 parts water). Rinse and Dry.
- When using humidifier bottle use distilled water and ensure water level between minimum and maximum fill marks on the bottle
- Check that the humidifier lid seal is in good condition.
- Bottle to be cleaned and re-filled every day

4.2 Outside Cabinet

- Use a mild household cleaner applied with a damp cloth or sponge to clean the exterior of the concentrator, and then wipe all surfaces dry. Cleaning to be done as and when deemed appropriate.

4.3 Cabinet Filters, Compressor Inlet Primary Filter

- The removable Cabinet Air filter in front and back side of machine and the Compressor Inlet Primary Filter, must be cleaned weekly with air blower to remove dust, after approximately 100 hours of use. More frequent cleaning is recommended in dusty environments. Do not use water to clean filters. The filters must be completely dry at the time of putting in machine
- To replace filter remove the Cabinet filter cover by pushing the lock down and pulling out the cover

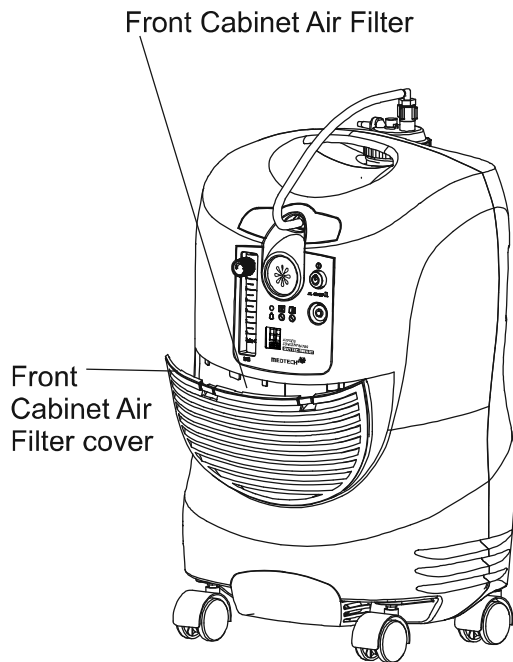

Fig 4.1

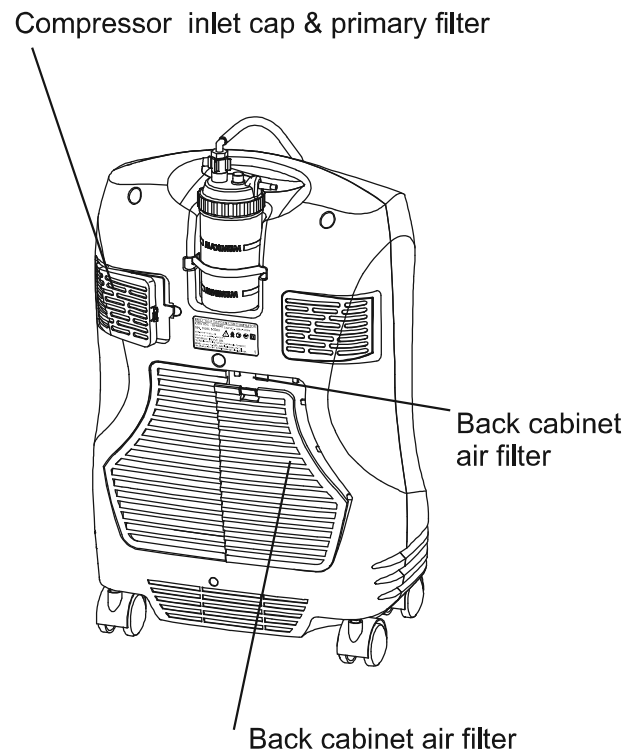

Fig 4.2

4.4 Compressor Inlet Secondary Filter

- Check filter every 3 months, replace filter every year, or more frequently depending on environment.
- Filter should be replaced if it appears clogged.
- Filter replacement should be more frequent in dusty environment.
- Filter cannot be dismantled for cleaning.
- To replace filter remove the compressor inlet cap by pushing the lock sideways and pulling out the cover.
- Remove the compressor inlet primary filter. The Compressor Inlet Secondary Filter can now be accessed.
- Remove by pulling out of machine by holding with fingers.
- Insert new filter in place by pushing in position with hand.

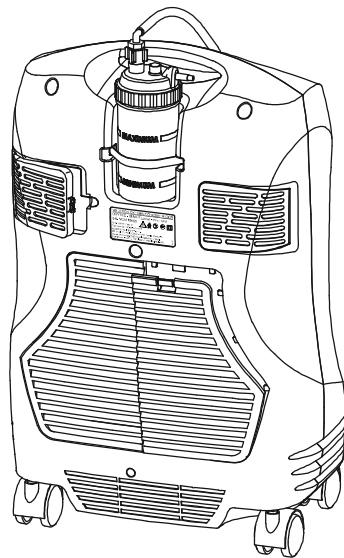

Fig 4.3

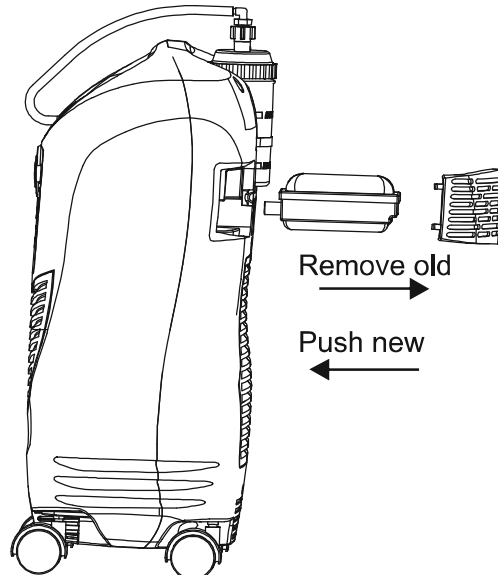

Fig 4.4

4.5 Nasal Cannula

- The nasal cannula and oxygen tubing should be used for one patient only.
- Do not share between patients.
- Use mild disinfectant solution to wipe clean and disinfect the parts from outside.
- Cleaning to be done every day.

5.0 Troubleshooting

If your concentrator fails to operate properly, consult your Equipment Provider, and refer to the troubleshooting chart on the following pages for probable causes and solutions



NOTE

Do not attempt any maintenance other than the possible solutions listed below.



NOTE

If the unit has not been used for an extended time period, it needs to operate for several minutes before power failure alarm can become functional



NOTE

The unit must be serviced or maintained by personnel authorised by the company only . Unauthorized servicing of the machine might result in machine malfunction and loss of warrantee

Problem	Probable cause	Solution
<p>Unit does not operate. Power failure condition causes an alarm to sound.</p> <p><i>E1</i></p>	<p>The power cord is not connected to the electrical outlet.</p> <p>No power at the electrical outlet.</p> <p>Circuit breaker on concentrator unit is activated</p>	<p>Check power cord at the electrical outlet for a proper connection.</p> <p>Check power source, wall switch, in-house fuse or circuit breaker/fuse.</p> <p>Press (for 1 Second) the circuit breaker reset button in the front of the unit.</p> <p>If the circuit breaker trips again or the alarm continues to sound after the unit is turned on, contact your Equipment Provider.</p>
<p>Limited, irregular or no oxygen flow.</p>	<p>Dirty or obstructed humidifier bottle, or leak present.</p> <p>Defective nasal cannula, or other oxygen</p>	<p>Remove the humidifier bottle, and if flow is restored, clean or replace the humidifier bottle.</p> <p>Remove and check accessories for kinks or obstructions. Replace if needed.</p> <p>Check cannula tubing connection.</p>

<p>Condensation collects in the oxygen tubing when you use a humidifier bottle</p>	<p>Dirty or obstructed humidifier bottle, or leak present</p> <p>Defective nasal cannula, or other oxygen accessories, i.e. oxygen tubing.</p> <p>Cannula tubing</p>	<p>Make sure unit is positioned away from curtains or drapes, hot air registers or heaters,</p> <p>Be certain to place the unit so all sides are at least 1 foot (30 cm) away from a wall or other obstruction.</p> <p>Do not place the unit in a confined area.</p> <p>Refill humidifier bottle with cold water. DO NOT OVERFILL.</p> <p>Allow oxygen tubing to dry out, or replace with new tubing.</p>
<p>The ON/OFF button is ON, the compressor is operating, there is a</p>	<p>Internal electrical fault. Pneumatic circuit fault.</p>	<p>Set ON/OFF power switch to OFF position, Use your reserve oxygen supply (if provided), and consult your Equipment Provider immediately.</p>
<p>The compressor stops in mid-cycle, then starts again after a few minutes.</p>	<p>Compressor thermal safety device has been activated.</p> <p>Fan is not working. Dirty Filters.</p>	<p>Stop the device and wait for it to cool down. Clean cabinet Filter & Compressor Inlet Primary Filter</p> <p>Check Compressor Inlet primary & Secondary Filter. replace if clogged</p> <p>Reset the circuit breaker, Start up again.</p> <p>If the device does not start, contact your equipment supplier.</p>
<p>All other problems. <i>E2, E3, E5, E7, E4, E6</i></p>		<p>Set ON/OFF power switch to the OFF position, use your reserve oxygen supply (if provided), and consult your Equipment Provider immediately.</p>

E4		<p>Check if the flow on the machine is above 5 LPM mark. If yes adjust flow regulator knob to reduce flow to 5 LPM or below 5 LPM. Shut off and restart the machine check the flow is not above 5 LPM adjust if necessary. Wait for 10 minutes. If alarm still comes.</p> <p>Set ON/OFF power switch to the OFF position, use your reserve oxygen supply (if provided), and consult your Equipment Provider immediately.</p>
E6		<p>Check the voltage supply to the machine is within the range as mentioned on the machine panel. You should get a qualified electrician to check the voltage</p> <p>If voltage is appropriate then shut off the machine for 10 minutes. Restart the machine if the problem still persists then,</p> <p>Set ON/OFF power switch to the OFF position, use your reserve oxygen supply (if provided), and consult your Equipment Provider immediately.</p>



NOTE

In any type of fault condition it is a good practice to immediately shut off the machine. Wait for the machine to cool down for approximately 20 minutes.

Restart the machine If the fault comes again. Note the alarm indicated on your machine. See section 3.5 Alarms and Indications Shut off the machine and call your service provider and inform him about the alarm indicated on your machine.

Do not attempt to service the machine yourself The machine should only be serviced by personnel authorised by the company.

Unauthorized service or disassembly of the machine can cause serious and permanent damage to the machine

If the machine problem is not solved with the indicated measures .Please inform authorized service personnel and inform the status of the indicator, display and buzzer.



Disconnect the power cord from the electrical outlet before cleaning, servicing or maintenance. Not disconnecting the power cord from electrical outlet may cause electrical hazard.

6.0 Product Specifications

Oxygen Concentration	Flow Rate	O2 Concentration
	1 – 5 lpm	90% + 5.5% / - 3%
	Based on STPD (standard temperature and pressure, dry) conditions: 101.3 kPa, 20°C	
Electrical Requirements Electrical requirements are specific to individual models and are not interchangeable Please check machine back panel for exact electrical requirements	120 VAC + - 10% / 60 Hz 230 VAC + - 10% / 50 Hz 230 VAC + - 10% / 60 Hz	
Power Consumption	300 watts approximately	
Dimensions	380 mm x 250 mm x 600 mm (L x W x H)	
Weight	35 lbs (16 kg) approximately	
Alarms	Power Failure Low Pressure High Pressure High Temperature Valve Error Indication for Oxygen Concentration (in the Models Oxytec Pro only)	
Electrical Shock Protection	Class II, Type B	
Medical device classification as per MDD 93/42/EEC: 2007	Class IIa	
Operating requirements	Temperature min. +16°C-max. 40°C Humidity min. +30-85% RH , pressure min.780 hPa,max.1013hPa P	
Storage & Transport requirements	Temperature min. -10°C-max. 60°C Humidity min. 10%, max 95% RH Non condensing	
Sound pressure level Sound power level	50 dBA 60 dBA	
Maximum outlet pressure: a. Normal condition b. Single fault conditions	60 kPa 60 kPa	



Device operation above or outside of the Voltage, LPM, Temperature (10 to 40°C), Humidity (30-85%RH) and/or Altitude values (0 to 2136m) may decrease oxygen concentration levels and quality of therapy.



NOTE

The equipment and accessories are tested at the maximum flow and maximum operating pressure mentioned above and found to maintain basic safety and essential performance.

CONFORMITY WITH IEC 60601-1 :

"The manufacturer, assembler, installer or distributor are not considered to be responsible themselves for the consequences on the safety, reliability and characteristics of a device unless:

The assembly, fitting, extensions, adjustments, modifications or repairs have been performed by persons authorized by the party in question,

The electrical installation of the corresponding premises complies with local electrical codes. (e.g. IEC / NEC).

The device is used in accordance with the instructions in the patient instruction booklet. If the replacement parts used for the periodic servicing by an approved technician do not comply with the manufacturer's specifications, the manufacturer is not responsible in the event of an accident.

This device complies with the requirements of 93/42/EEC European Directive but its operation may be affected by other devices being used near by, such as diathermy and high frequency electro-surgical equipment, debrillators, short wave therapy equipment, mobile telephones, CB and other portable devices, microwave ovens, television, induction plates or even remote control toys or any other electromagnetic interferences which exceed the levels specified by the EN 60601-1-2 : 2007 standard.

Standards Compliance:

This device is designed to conform to the following standards:

IEC 60601-1 Medical Electrical Equipment, Part 1: General Requirement for Safety.

IEC 60601-1-2 : 2007, Medical Electrical Equipment, Part 1-2: General Requirement for Safety - Collateral Standard: Electromagnetic Compatibility - Requirements and Tests.

(ISO 80601-2-69: 2014) Oxygen Concentrators for Medical Use - Safety Requirements

STATEMENT OF INTENDED USE:

The Oxygen Concentrator passes the room (atmospheric) air through a regenerative adsorbent material called molecular sieve. This material separates the oxygen from the nitrogen and other gases. The result is a constant supply of high concentration supplemental oxygen that is delivered to the patient.

The device can be used with adult or pediatric patients. The device to be used for medical use only. The device is not intended to be life supporting or life sustaining.

For detail Instruction Video:

How to use:- <https://youtu.be/lpv1wA9DIKk>

How to clean:- <https://youtu.be/4pij-Fg-duw>

or Search for Medtech Oxygen Concentrator
on Youtube.com

7.0 Spare Parts / Accessories / Reorder No.

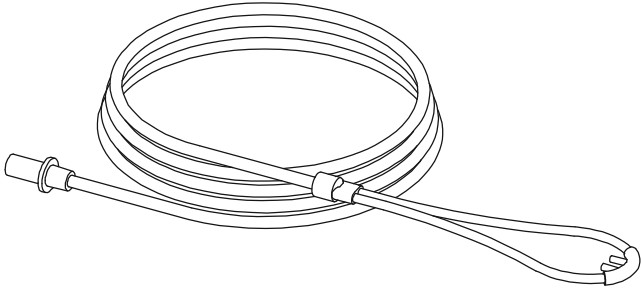
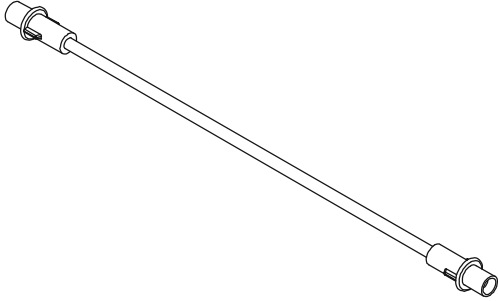
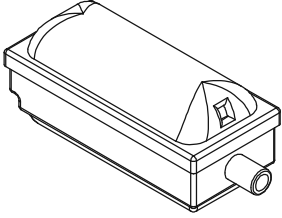
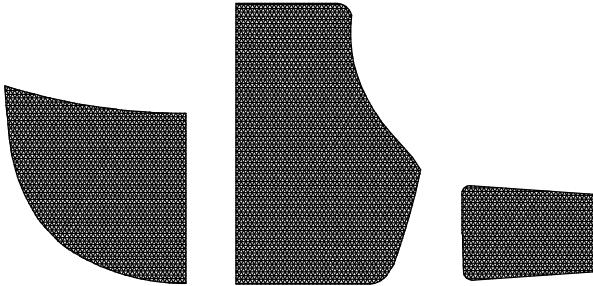













<p>Humidifier P01012-00-00</p> <p>Threaded Adaptor P01010-00-00</p>	
<p>Cannula with 2 m (7 ft) tubing P01011-00-00</p>	
<p>Oxygen Outlet Tubing P01075-00-00</p>	
<p>Compressor Inlet Secondary Filter P01018-00-00</p>	
<p>Filter Set – Includes Cabinet filter Front, Cabinet filter back & Compressor inlet primary filter</p> <p>P01194-00-00 P01195-00-00 P01196-00-00</p>	

8.0 Disposal

Method of disposing of waste: All waste from the Oxygen Concentrator must be disposed of using the appropriate methods in accordance with local regulations where disposed

Method for disposing of the device: In order to preserve the environment, the concentrator must be disposed of using the appropriate methods in accordance with local regulations where disposed

9.0 Symbols / Warning

Symbols:	Description
	Power On
	Power Off
	Switch
	Type B device
	Class II device
	No Open source Flame; Fire, Open ignition near machine
	Do not Smoke near machine
	CAUTION
	Consult instruction for use
	Keep the vertical position
	Frangible - handle with care
	Indicator
	Temperature Limit
	Date of Manufacture
	Manufacturer

10.0 Limited Warrantee

This device is made under strict quality control & utmost care is

- This unit is warranted for a period of 1 years or 5,000 hours use whichever is earlier.
- This card must be duly filled in, stamped & signed by the dealer.
- This card & relevant invoice must be preserved and presented to the dealer when the unit is sent for repairs.
- We undertake to repair or replace at our discretion any part which was originally defective, provided the unit was not tampered with or mishandled.
- It shall be customer's responsibility to deliver the unit to the authorized service station; freight prepaid & collect the unit from service station after repairs.
- The warranty is only against manufacturing defects & shall not be applicable in case of damage due to accident, acts of nature, loss of components, intentional damage, improper installation or if it was opened or serviced by unauthorized persons.
- **The warranty is void, if the set is not operated according to instruction given in the "Patient Instruction booklet", If any repair work is carried out by persons other than authorised company personnel, defects are caused by improper or reckless use, which shall be determined by**
- The warranty shall not extend towards the payment of compensation to anyone or entitle the customers to replacement of the products as a whole.
- The warranty expressly excludes every condition or warranty whether statutory or otherwise, or any claim for consequential loss or damage.
- Warranty does not cover accessories external to the equipment, defects caused due to causes beyond control like lighting, abnormal voltage, acts of God or while in transit to service center or to purchasers/premises.
- In the event of a defect being noticed in the equipment during the warranty period, the company or its authorized customer care center/service dealer reserves the right to retain any parts / or components replace at its discretion.
- **IMPORTANT: Warrantee is not applicable for kit, filters and accessories components. Kit, filter and accessories should be replace from time to time as needed or as per doctor's advise.**

OXYGEN CONCENTRATOR

WARRANTY CARD

Subject to Mumbai Jurisdiction only

No.

Model

Serial No.

Invoice No. Date :

Stamp and Signature
of Dealer

Name and Address
of Dealer



*Conditions Apply

NOTES: _____

Innovation in healthcare can help people monitor their health conveniently. But mere innovation is not enough. What is equally important is that everyone should have access to it

At MEDTECH we are doing just that. We are democratizing innovation

It involves continuous R&D to make existing products better and to create better new products

It involves creating products that customers can use economically for years together.

It involves creating services to support these products, so customers can use them over a period of time

Mfg. By

MEDTECH LIFE PRIVATE LIMITED

Regd. address : B6,Byculla Service Industries, D.K.Marg, Sussex Road, Byculla (East), Mumbai 400027, Maharashtra, INDIA.

Customer Care No.+917208088720

E-Mail:support@medtechlife.com

Website : www.medtechlife.com



Plot No. 05, Morai Industrial Park, S.No. 315/5, Morai, Valsad, Gujarat-396185

EC|REP OBELIS S.A.

Bd. Général Wahis 53, 1030 Brussels, BELGIUM
Tel.:+(32)2. 732.59.54 E-mail:mail@obelis.net